

Fitting Windows

General Help Guide

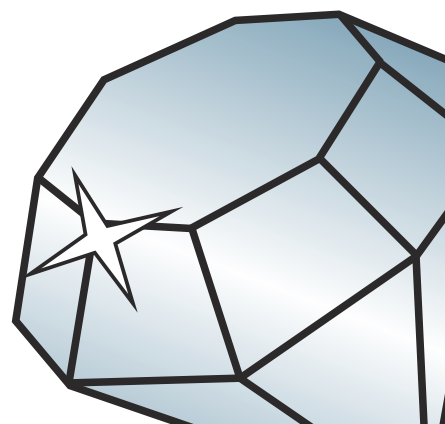

DURATION
WINDOWS



Disclaimer

Please note that Duration Windows is only a manufacturer of windows and do not install any of our products.

This is a general fixing guide for windows and is not product specific from pages 3-7.

Please use your own fitting judgement as dictated by the site and its design as this may change the parameters for install, which will not be outlined in this guide.

Also please note that Duration Windows do not provide any fixing screws for our products. These will need to be specified and purchased by the installer applicable to the product used and the site requirements.

Contents

Installation	3 - 4
Fixing Methods	5
Glazing	6
Sealing	7
De-glazing Fixed Windows (Heritage)	8
De-glazing Opening / Dummy Fixed Windows (Heritage)	9
De-glazing Fixed Windows (Modern)	10
De-glazing Opening / Dummy Fixed Windows (Modern)	11 - 12
Projection Cills	13
Bay Cill Assembly	14
Couplers	15
90° Corner Post	16
Bay Poles	17 - 18

Installation

Wherever practicable all four sides of the frame should be secured as follows.

- 1) Corner jamb fixings should be between 100 mm and 150 mm from the external corner.
- 2) No fixings should be less than 100 mm from the center line of a mullion or transom.
- 3) Intermediate fixings should be at centers no greater than 600 mm.
- 4) There should be a minimum of two fixings on each jamb.
- 5) On windows over 1800 mm wide, central head and sub-sill fixings should be provided.

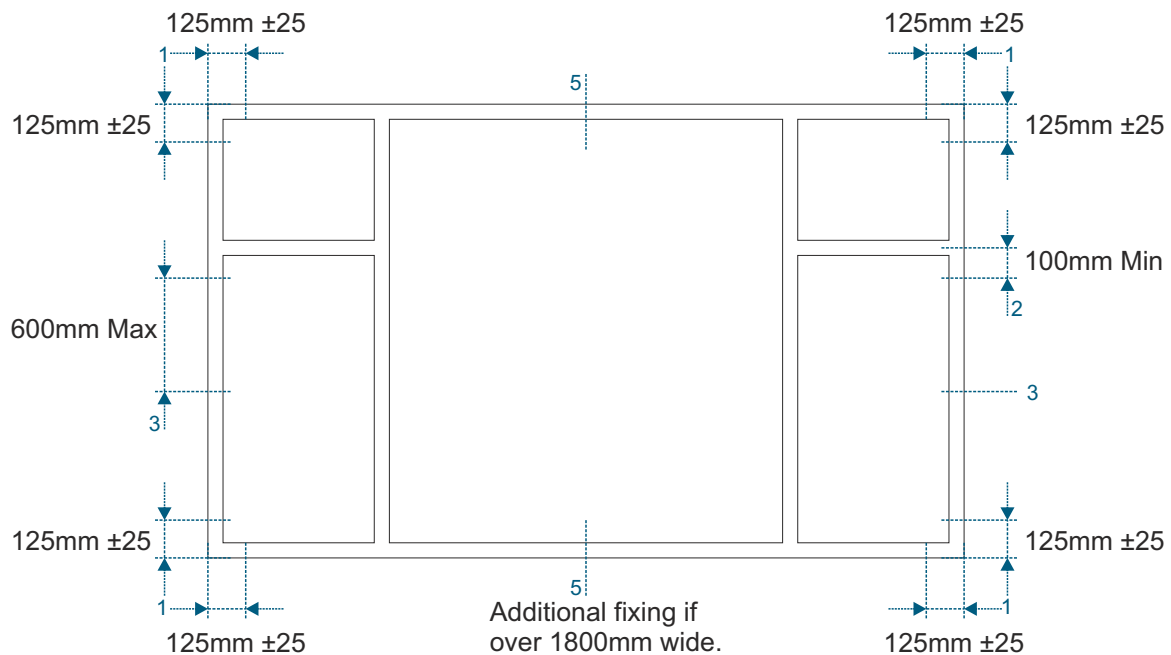

Coupled assemblies

Coupled assemblies are usually delivered to site as separate units, to ease handling and minimize damage. When building up components into the required assembly, care should be taken to keep coupling joints equal, and frames both aligned and plumb. When coupling joints are also to be used as expansion joints, they should have seals, such as bedding mastic, expanding bituminized tapes, or flexible polymer gaskets, placed within the joint during the assembly operation. It is not sufficient to rely solely on external pointing sealant.

Installation

Windows and doorsets should be installed plumb and square within the aperture, without twist, racking or distortion of any member, to operate correctly after installation.

Frame Placement

Replacement windows and doorsets should generally be positioned to minimize the amount of making good, taking into account the following points.

- The new frame should bridge the DPM. Any damaged DPM should be repaired.
- The frame should be set as far back in the reveal as is feasible for better weather performance.
- The correct movement gap should be provided.

New Build: The position of the window or doorset within the reveal is normally agreed at the time of original design and the installation should be in accordance with the agreed design. Most installation will be set back around 30mm from the front face of brick - but please check with any plans and designs done for the build.

Installation

Open Cavities

Open cavities discovered between inner and outer skins of brick or blockwork should be bridged or closed with an insulating material. Care should be taken to maintain the integrity of the DPM, and adequate purchase for fixing screws should be ensured, if need be with extended fixing lugs (only provided upon request for some products).

Installation packers

Installation packers should be used adjacent to fixing positions to prevent outer frame distortion during installation. Installation packers should be resistant to compression, rot and corrosion. They should span the full depth of the outer frame. The fixings should be tightened so that the frame is held securely against the packers. Over-tightening can lead to distortion and should be avoided. Some lugs need to be packed off the substrate to prevent distortion. Where enhanced security is required, additional packers might be necessary adjacent to hinge and locking points.

Finishing

Debris or contaminants should be removed and any drainage paths should be cleared. Internal reveals should be made good as agreed, ready for the purchaser to redecorate if necessary. Any materials such as trims or sealant should not be applied on top of loose material. Protective tapes should be removed as soon as practicable, as ageing of tapes can cause difficulties in removal. Sand and cement should not be used to fill the gap between the outer frame and the substrate except for backfill for steel windows, nowadays usually limited to windows in stone surrounds or interior fair-faced brick and concrete. Where the replacement product has a smaller front to back dimension than the original, then there might be a mastic and/or paint line visible on the substrate which should be removed as much as practicable or covered with a trim. The method of, and responsibility for, repair to any render should be as agreed with the purchaser.

Installation

Fixing Methods

There are two principal methods of fixing available, which may be used separately or in combination: through frame fixings and lug fixings. The surveyor is responsible for specifying the nature, location and quantity of the fixings. It is the responsibility of the installation company to ensure suitability.

Fixing Considerations

- Fixing methods are affected by:
- the presence or absence of a wall cavity;
- the nature and condition of any cavity;
- the relative position of the frame and cavity;
- the position of the plaster line and the need to minimize disturbance and damage to interior decorations;
- the design of the reveal;

Placement

Wherever practicable the sides of the frame should be secured in accordance with the recommendations. If it is impossible to follow these recommendations, then, on large contracts, alternative positions should be agreed with the purchaser, and on domestic installations, the closest possible fixing positions should be used.

Foam Fixing

The presence of pre-cast concrete or steel lintels can make it impracticable or pose severe difficulties in achieving the recommended fixing distances. In these instances the use of polyurethane foam has proved a useful adjunct to mechanical fixings, but foam fixings should under no circumstances be used as the sole method of fixing the entire frame into the reveal.

Lug Fixing / Direct Fixing

A fixing lug anchor can be applied to the outerframe then the lug connected to the sub structure. Screws should be sized to penetrate at least 25mm into timber, plugged holes in brick, block, or masonry, unless equivalent demonstrable provision can be made by other means, e.g. in accordance with an appropriate structural code. Connections to steelwork up to 2mm thick such as folded sheet lintels should be made with appropriate thread cutting screws. Connections to steelwork over 2mm thick should be either into pre-tapped holes with machine screws of minimum 5mm diameter, or with power-driven hardened self-drilling screws. Other proprietary mechanical fixing methods are available but will not necessarily be suitable for a given application. Fixings should be at least corrosion-resistant.

When coupling aluminum products a self tapping screw that is corrosion / rust resistant will be needed. Sizes of these screws will depend on the type of product being coupled - please see product manuals on our website.

Glazing

Windows and doorsets in most cases are delivered temporally glazed for ease of delivery and to insure all parts arrive safely. We advise that all glass is removed and re-packed to suit site installation. Some instances will dictate that the glass is delivered separate to the frames due to sizes etc.

Plastic Glazing Packers

The below images shows the recommended positions of the plastic packers recommended in BS 6262.

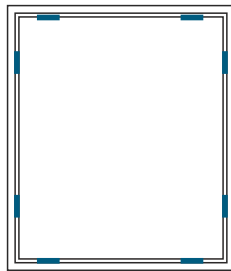

Fixed

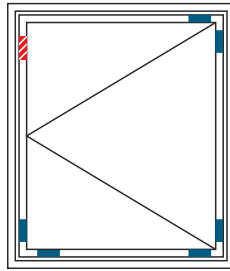

Side Hung

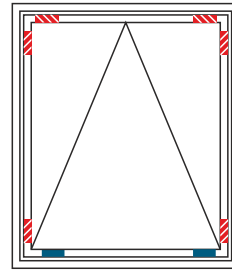

Top Hung

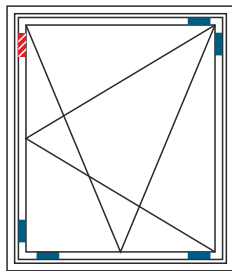

Tilt & Turn

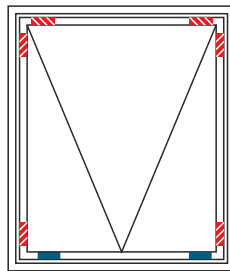

Tilt Only

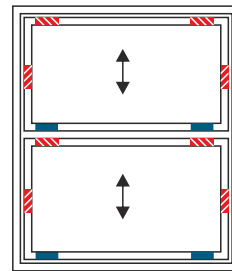

Vertical Slider

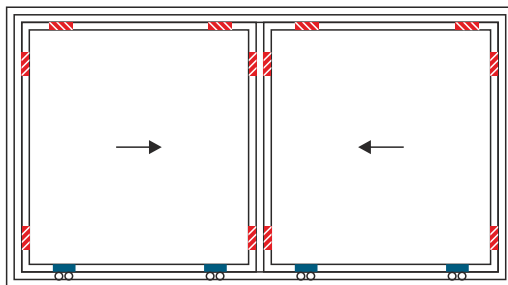

Horizontal Slider



Please note this is a guide only - the amount of packing needed will need to be judged on site appropriate to the installation. Extra packers may need to be sourced by installers on site.

Sealing

The purpose of perimeter sealants is to repel water and prevent air leakage in the face of differential movement between the aperture and the window or doorset. Suitable sealants exhibit and retain flexibility and adhesion over this period. The movement class for the sealant will depend on the substrate material, the frame material and the dimensions of the joint between the frame and the opening.

Sealant Type

Sealants should be tested and classified in accordance with BS EN ISO 11600. Unless an unusual and specific known requirement determines otherwise, they should be of low modulus and high elasticity, with movement capability of at least 20%. These characteristics should be identified on their packaging as class 20LM or 25LM.

Considerations

Perimeter joints should be sealed, with a sealant appropriate to:

- the frame surface;
- the substrate material;
- joint size and configuration;
- anticipated joint movement;
- anticipated exposure to weather.

It is essential that sealants are compatible with the frame material and the substrate. The presence of old oil-based mastics and bituminous DPMs can adversely affect the behaviour or appearance of otherwise correctly specified and applied sealants, through the migration of hydrocarbons to the surface of the new sealants. Consequent photo-oxidation of the migrant products can affect sealant performance and produce discoloration. This risk should be avoided by removal of unwanted mastic and by keeping sealant away from DPMs. In situations where sealants rely upon atmospheric moisture to initiate curing, deep filling should be avoided.

Sealant Backing

The sealant should be applied against a firm backing so that it is forced against the sides of the joint during application. To avoid failure in service, the sealant should not adhere to the backing because this would restrict the lateral movement of the joint. These recommendations can be achieved through the use of a closed-cell, oversize circular foam strip. For aluminium framed windows and doorsets, recommended best practice is to have an insulating fill inserted or injected wherever practicable around their full perimeter behind the external seal between frame and structural opening.

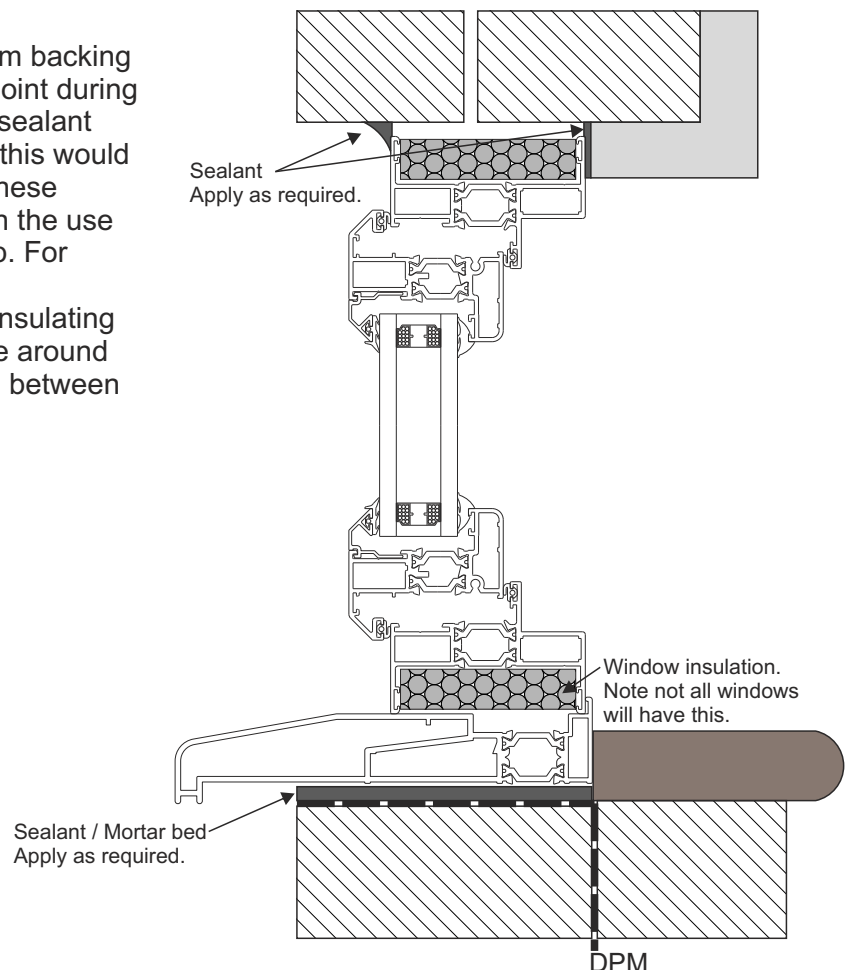

De-Glazing Standard Fixed Windows

Heritage Stepped

- Remove internal **wedge gaskets**.
- Remove internal **aluminum spacer**.
- Once these are removed the **glass** can be pushed back from the outside into the space created.
- When the **glass** is pushed back the **external beads (& external gasket)** will become loose and can be un-clipped by pushing & rotating them out.
- With all **beads** removed the **glass** will have enough room to be removed from the external side of the frame.
- To re-glaze, reverse the process making sure to pack the glass correctly.

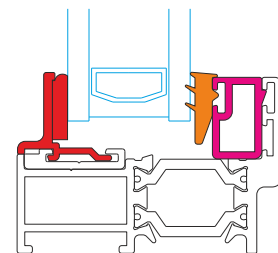

This process is the same for an odd leg window.

Heritage Puttyline

- Remove internal **wedge gaskets**.
- Remove internal **aluminum spacer**.
- Once these are removed the **glass** can be pushed back from the outside into the space created.
- When the **glass** is pushed back the **external beads (& external gasket)** will become loose and can be un-clipped by pushing & rotating them out.
- With all **beads** removed the **glass** will have enough room to be removed from the external side of the frame.
- To re-glaze, reverse the process making sure to pack the glass correctly.

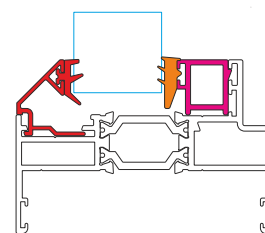
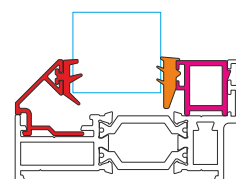

Royale Stepped Or Puttyline (Coupled)

- Remove internal **wedge gaskets**.
- Once these are removed the **internal beads** can be un-clipped by pushing forward & rotating out.
- With all **beads** removed the **glass** will have enough room to be removed from the internal side of the frame.
- To re-glaze, reverse the process making sure to pack the glass correctly.

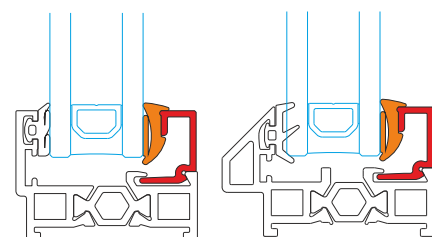

This process is the same for an odd leg window.

Royale Stepped Or Puttyline (Transom)

- Remove internal **wedge gaskets**.
- Remove internal **aluminum spacer**. (stepped look only)
- Once these are removed the **glass** can be pushed back from the outside into the space created.
- When the **glass** is pushed back the **external beads (& external gasket)** will become loose and can be un-clipped by pushing & rotating them out.
- With all **beads** removed the **glass** will have enough room to be removed from the external side of the frame.
- To re-glaze, reverse the process making sure to pack the glass correctly.

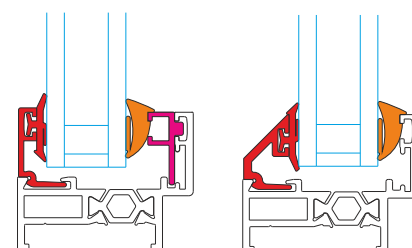

Heritage Stepped

- Remove internal **wedge gaskets**.
- Once these are removed the **internal beads** can be un-clipped by pushing & rotating them out.
- With all **beads** removed the **glass** will have enough room to be removed from the internal side of the sash.
- To re-glaze, reverse the process making sure to toe and heel the glass correctly on openers or packed correctly for dummy fixed.

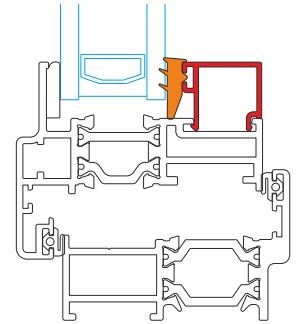

Heritage Puttyline

- Remove internal **wedge gaskets**.
- Once these are removed the **internal beads** can be un-clipped by pushing & rotating them out.
- With all **beads** removed the **glass** will have enough room to be removed from the internal side of the frame.
- To re-glaze, reverse the process making sure to toe and heel the glass correctly on openers or packed correctly for dummy fixed.

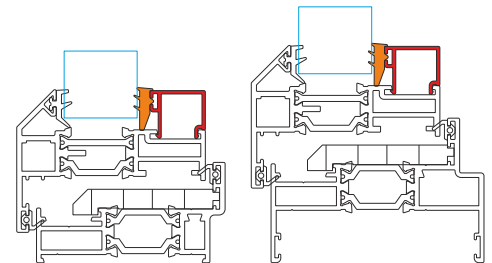

Royale Stepped Or Puttyline (Coupled)

- Remove internal **wedge gaskets**.
- Once these are removed the **internal beads** will become loose and can be un-clipped by pushing & rotating them out.
- With all **beads** removed the **glass** will have enough room to be removed from the internal side of the frame.
- To re-glaze, reverse the process making sure to toe and heel the glass correctly on openers or packed correctly for dummy fixed.

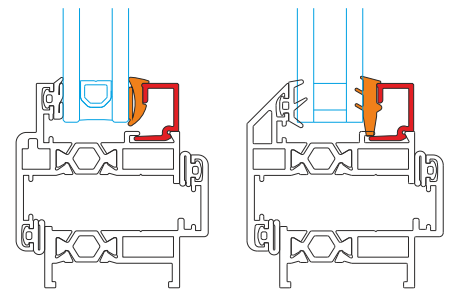

Royale Stepped Or Puttyline (Transom)

- Remove internal **wedge gaskets**.
- Once these are removed the **internal beads** will become loose and can be un-clipped by pushing & rotating them out.
- With all **beads** removed the **glass** will have enough room to be removed from the internal side of the frame.
- To re-glaze, reverse the process making sure to toe and heel the glass correctly on openers or packed correctly for dummy fixed.

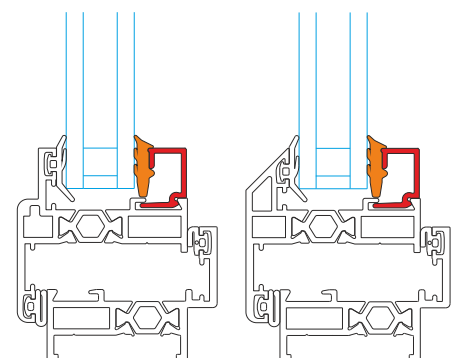

De-Glazing Standard Fixed Windows

Modern
Window Types

Alitherm 47

- Remove internal **wedge gaskets**.
- Once these are removed the **glass** can be pushed back from the outside into the space created.
- When the **glass** is pushed back the **external beads (& external gasket)** will become loose and can be un-clipped by pushing & rotating them out.
- With all **beads** removed the **glass** will have enough room to be removed from the external side of the frame.
- To re-glaze, reverse the process making sure to pack the glass correctly.

This process is the same for all alitherm 47 frames including odd leg windows.

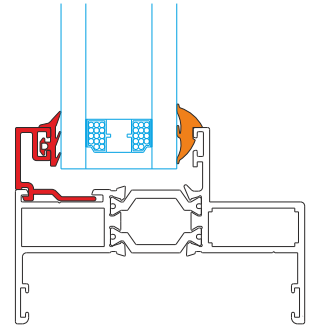

Duratherm 300

- Remove internal **wedge gaskets**.
- Once these are removed the **glass** can be pushed back from the outside into the space created.
- When the **glass** is pushed back the **external beads (& external gasket)** will become loose and can be un-clipped by pushing & rotating them out.
- With all **beads** removed the **glass** will have enough room to be removed from the external side of the frame.
- To re-glaze, reverse the process making sure to pack the glass correctly.

This process is the same for both 53mm and 70mm frames options.

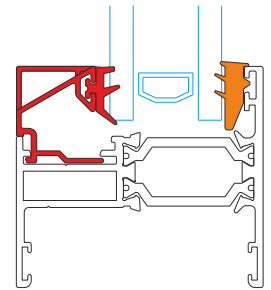

Premium / Premium Plus

- Remove internal **wedge gaskets**.
- Once these are removed the **glass** can be pushed back from the outside into the space created.
- When the **glass** is pushed back the **external beads (& external gasket)** will become loose and can be un-clipped by pushing & rotating them out.
- With all **beads** removed the **glass** will have enough room to be removed from the external side of the frame.
- To re-glaze, reverse the process making sure to pack the glass correctly.

This process is the same for all Premium & Premium Plus frames including odd leg windows.

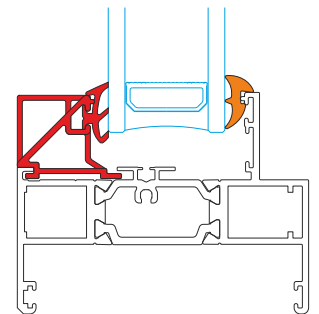

Premium Tilt and Turns

- Remove internal **wedge gaskets**.
- Once these are removed the **internal beads** will become loose and can be un-clipped by pushing & rotating them out.
- With all **beads** removed the **glass** will have enough room to be removed from the internal side of the frame.
- To re-glaze, reverse the process making sure to pack the glass correctly.

This process is the same for all frames in the system when ordering a tilt and turn combination.

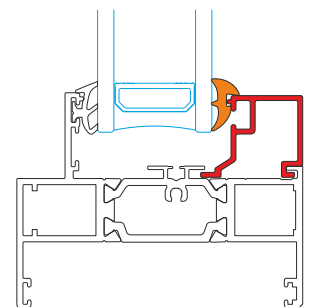

Alitherm 47 - Internally Glazed

- Remove internal **wedge gaskets**.
- Once these are removed the **internal beads** will become loose and can be un-clipped by pushing & rotating them out.
- With all **beads** removed the **glass** will have enough room to be removed from the internal side of the sash.
- To re-glaze, reverse the process making sure to toe and heel the glass correctly on openers or packed correctly for dummy fixed.

This process is the same for all openers & dummy fixed windows that are internally beaded.

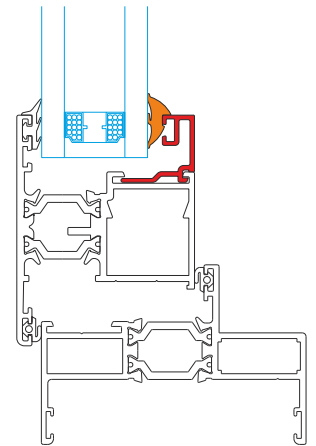

Alitherm 47 - Externally Glazed

- Remove internal **wedge gaskets**.
- Once these are removed the **glass** can be pushed back from the outside into the space created.
- When the **glass** is pushed back the **external beads (& external gasket)** will become loose and can be un-clipped by pushing & rotating them out.
- With all **beads** removed the **glass** will have enough room to be removed from the external side of the frame.
- To re-glaze, reverse the process making sure to toe and heel the glass correctly on openers or packed correctly for dummy fixed.

This process is the same for all openers & dummy fixed windows that are externally beaded.

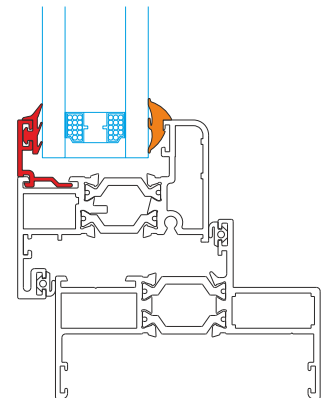

Premium / Premium Plus - Internally Beaded

- Remove internal **wedge gaskets**.
- Once these are removed the **internal beads** can be un-clipped by pushing & rotating them out.
- With all **beads** removed the **glass** will have enough room to be removed from the internal side of the sash.
- To re-glaze, reverse the process making sure to toe and heel the glass correctly on openers or packed correctly for dummy fixed.

This process is the same for all openers & dummy fixed windows that are internally beaded.

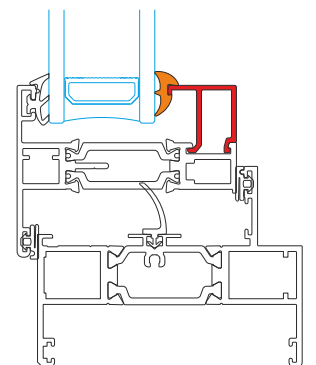

Premium / Premium Plus - Externally Beaded

- Remove internal **wedge gaskets**.
- Once these are removed the **external beads** will become loose and can be un-clipped by pushing & rotating them out.
- With all **beads** removed the **glass** will have enough room to be removed from the external side of the frame.
- To re-glaze, reverse the process making sure to toe and heel the glass correctly on openers or packed correctly for dummy fixed.

This process is the same for all openers & dummy fixed windows that are externally beaded.

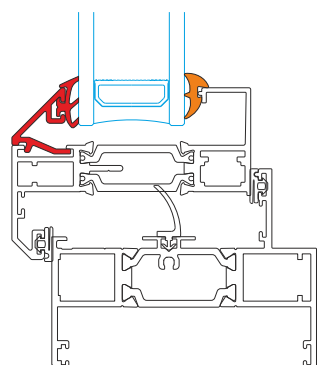

De-Glazing Opening / Dummy Fixed Windows

Modern
Window Types

Duratherm 300

- Remove internal **wedge gaskets**.
- Once these are removed the **internal beads** can be un-clipped by pushing & rotating them out.
- With all **beads** removed the **glass** will have enough room to be removed from the internal side of the sash.
- To re-glaze, reverse the process making sure to toe and heel the glass correctly on openers or packed correctly for dummy fixed.

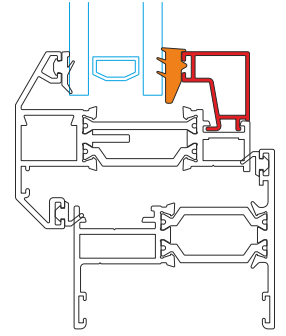

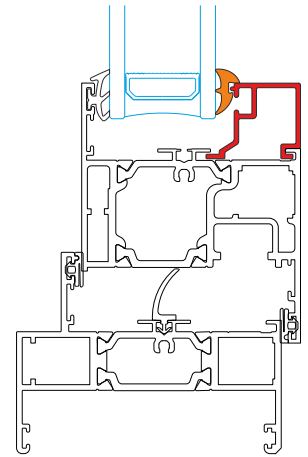

Premium Tilt And Turns

- Remove internal **wedge gaskets**.
- Once these are removed the **internal beads** will become loose and can be un-clipped by pushing & rotating them out.
- With all **beads** removed the **glass** will have enough room to be removed from the internal side of the sash.
- To re-glaze, reverse the process making sure to toe and heel the glass correctly on openers or packed correctly for dummy fixed.



Projection Cills

-  Internal Section Of Coupler
-  External Section Of Coupler
-  Advised Area For Sealing

For Alitherm 47, Heritage Stepped, Flush Casement or Duratherm 300

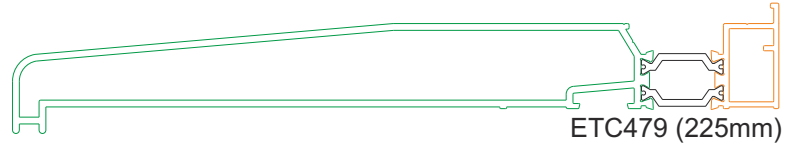
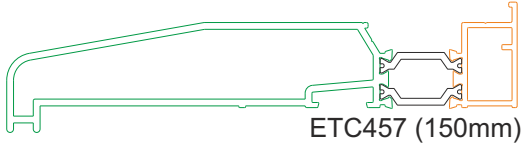
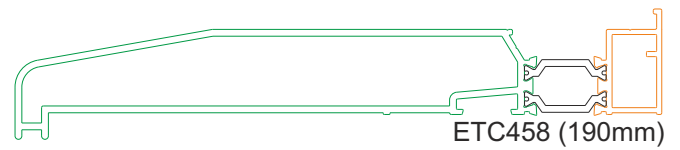
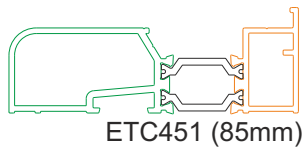

- 1) Clip the cill end cap into place - this also needs to be sealed using the appropriate sealant. If you have ordered cill horns you first need to prepare the cill to suit your needs on site - then cut the cill end cap to match and seal in place.
- 2) Bed projection cill down on silicone.
- 3) Screw fit into position.
- 4) Please ensure to silicone join all screws to the base for water protection.
- 5) Seal along both ends (sides) of the cill as well as the back lip (upstand) as much as possible to create a dam.
- 6) Once seal is applied lift window into position pushing it back tight against the cill upstand.
- 7) Fix window to cill as needed making sure to seal each screw in place for water protection.

The seal will extend on the surface of the cill by the size of the frame you are using - check this before starting.

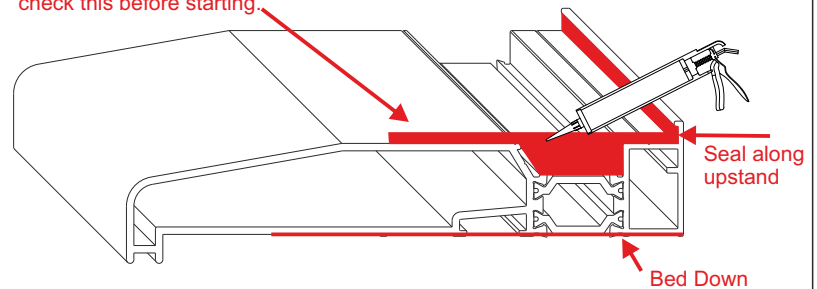

For Premium, Premium Plus and Premium Tilt and Turns

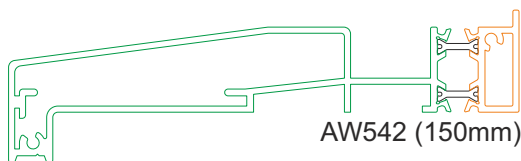
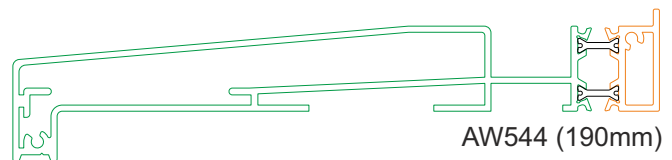
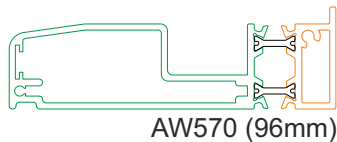

- 1) Screw the cill end cap into place using a 3.9 x 13mm self drilling pan head screw - this also needs to be sealed using the appropriate sealant. If you have ordered cill horns you first need to prepare the cill to suit your needs on site - then cut the cill end cap to match then screw and seal in place.
- 2) Bed projection cill down on silicone.
- 3) Screw fit into position.
- 4) Please ensure to silicone join all screws to the base for water protection.
- 5) Seal along both ends (sides) of the cill as well as the back lip (upstand) as much as possible to create a dam.
- 6) Once seal is applied lift window into position pushing it back tight against the cill upstand.
- 7) Fix window to cill as needed making sure to seal each screw in place for water protection.

The seal will extend on the surface of the cill by the size of the frame you are using - check this before starting.

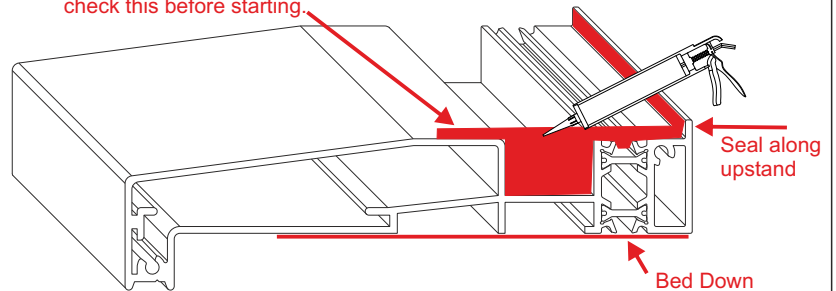

Bay Cill Assembly

For Alitherm 47, Heritage Stepped, Flush Casement or Duratherm 300

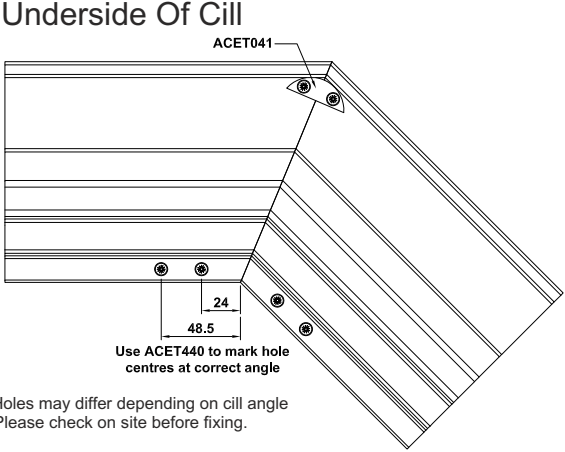
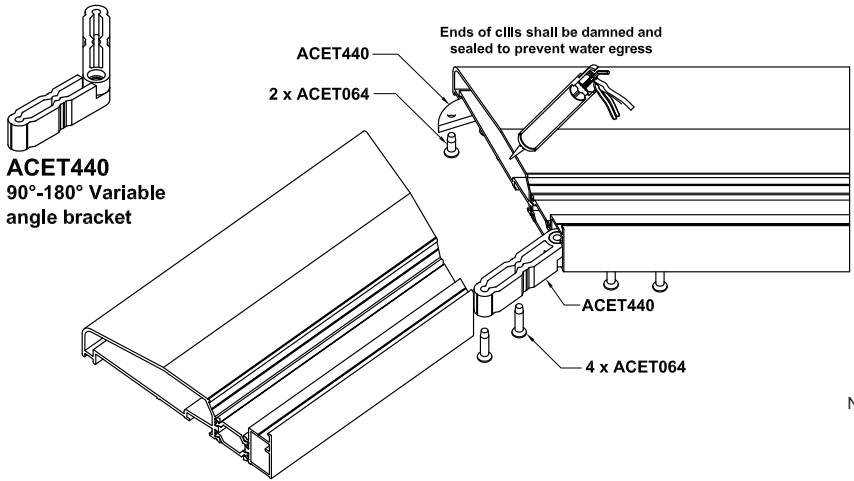

For Premium or Premium Plus Windows and Premium Tilt and Turns



Stage One: Position Cill Spigot (cut to desired angle*) into cill profile and slide cill nose spigot into the front edge cill groove.

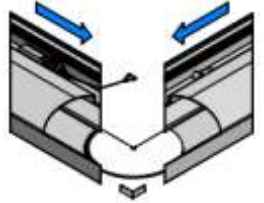

Stage Two: Move the cill sections in towards each other until the mitred faces touch. Seal this joint with appropriate sealant.

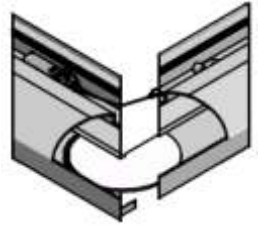

Stage Three: Complete the cill assembly by placing the latch cable over the hook and lowering to form a secure connection. The fixing position of the cable latch & cable hook will need to be judged on site to suit the desired angle and tightness needed.

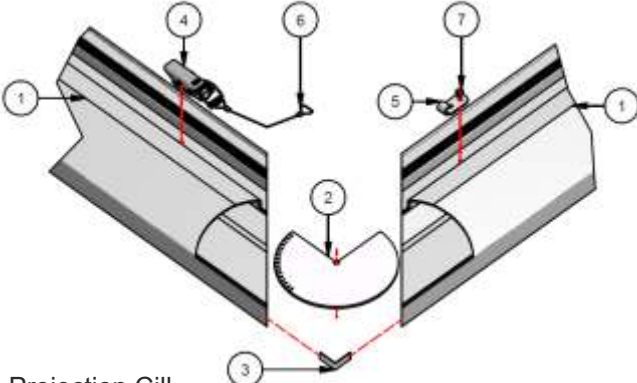

- 1) Projection Cill
- 2) Universal Cill Spigot
- 3) Cill Nose Spigot
- 4) Cable Latch
- 5) Cable Hook
- 6) Jointing Cable
- 7) 3.5 x 12 Posi Pan S/Drill S/Tap Screw

*Universal cill spigot is marked at 5 degree angular increments to allow for accurate cutting to desired angle on site.

Couplers

- Internal Section Of Coupler
- External Section Of Coupler
- Advised Area For Sealing

For Alitherm 47 or Heritage Stepped

For Alitherm 47

For Flush Casement

W20051

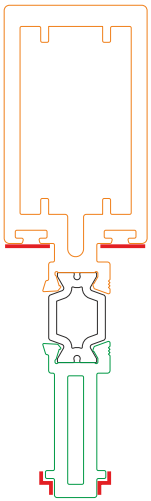

W20053

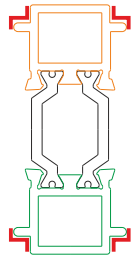

ETC517

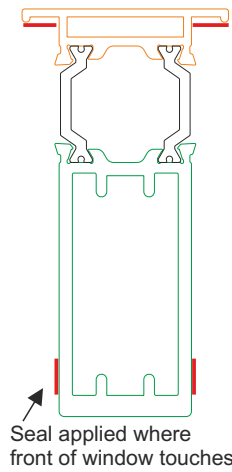

ETC053

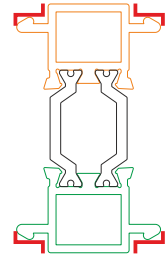

For Duratherm 300

ETC353

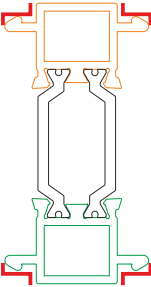

ETC356

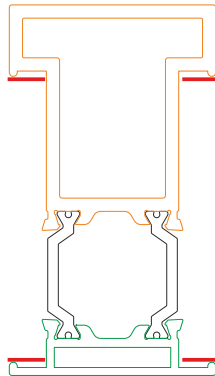

ETC357

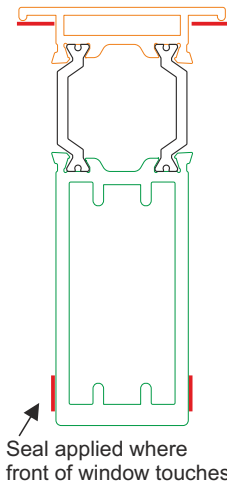

ETC853

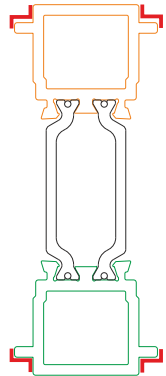

For Premium or Premium Plus Windows and Premium Tilt and Turns

AW705

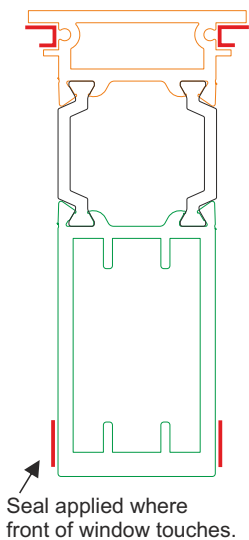

AW702

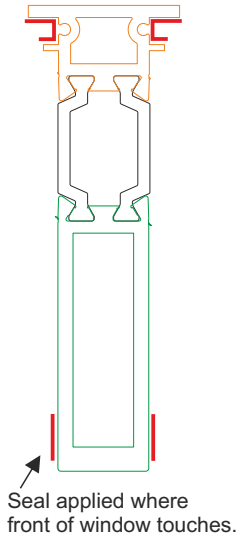

AW706

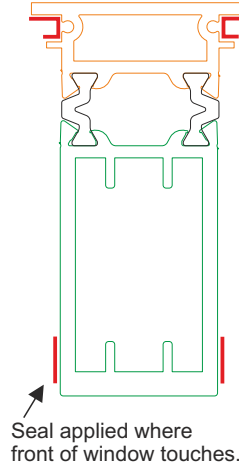

AW703

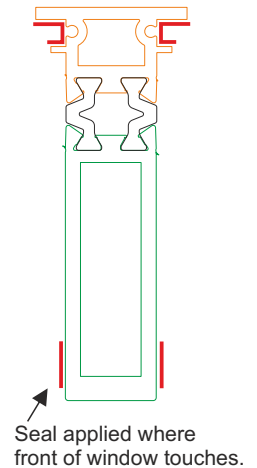

Note this is only a suggestion of the internal, external and sealing positions of the couplers for what we feel works best.

Corner Posts

- Internal Section Of Corner Post
- External Section Of Corner Post
- Advised Area For Sealing

For Alitherm 47, Heritage Stepped Or Flush Casement

ETC047 (47mm)

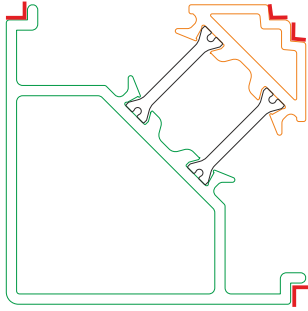

For Alitherm 47 Or Duratherm 300

ETC048 (70mm)

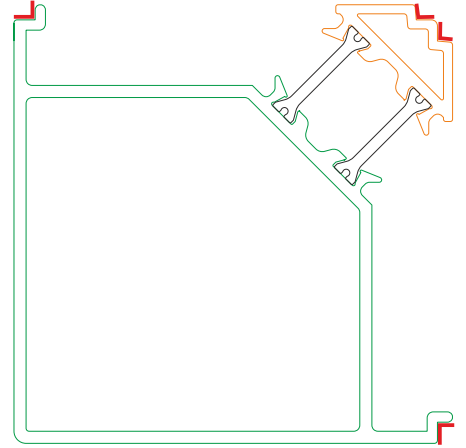

For Duratherm 300

ETC347 (53mm)

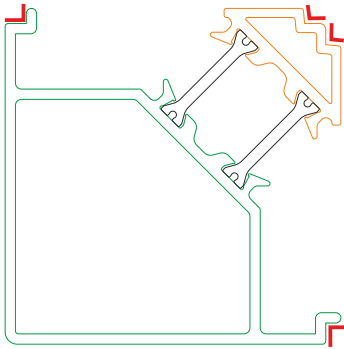

For Premium or Premium Plus Windows and Premium Tilt and Turns

AW721 (58mm)

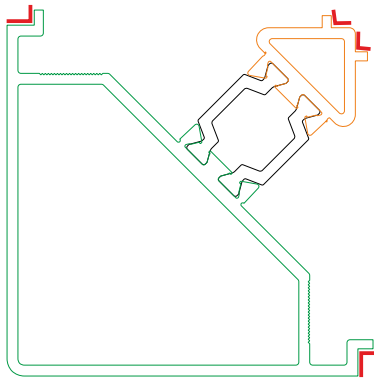

AW720 (70mm)

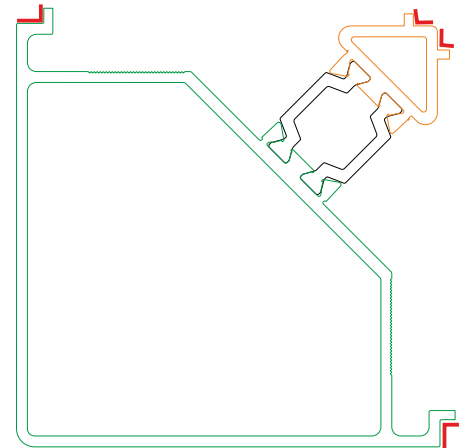

Bay Poles

- Internal Section Of Corner Post
- External Section Of Corner Post
- Advised Area For Sealing

For Alitherm 47 (70mm Frames Only)

ETC040 (120° - 136°)

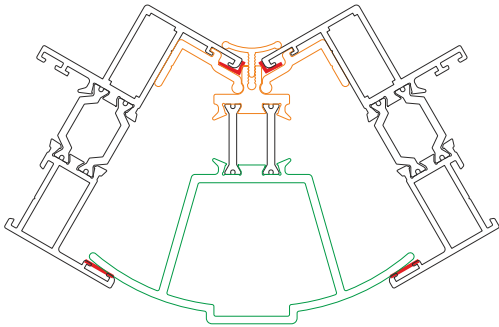

ETC041 (137° - 155°)

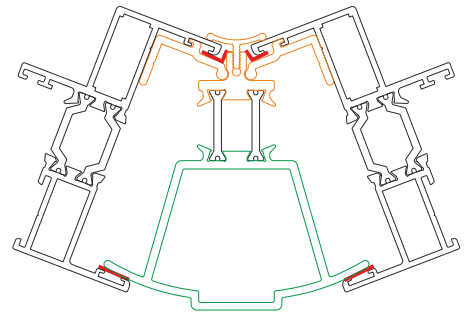

ETC042 (156° - 170°)

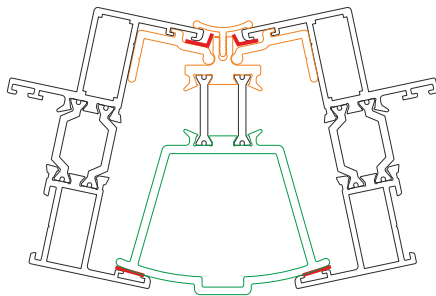

ETC869 (Variable)

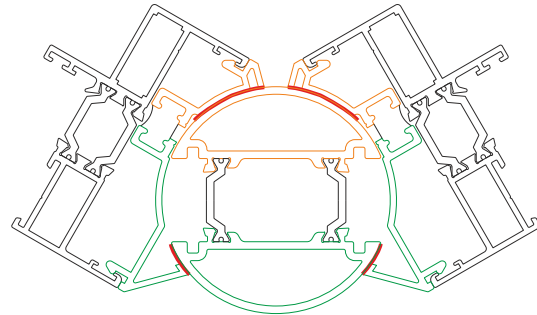

For Alitherm 47, Duratherm 300 or Flush Casement (47mm)

ETC869 (Variable)

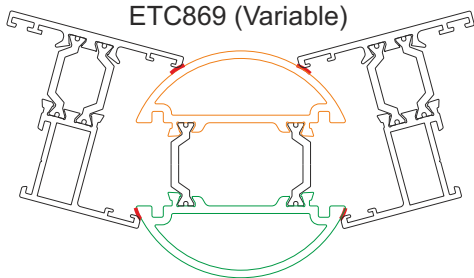

*Note on any bay assembly, packing may be required to hold poles in desired location while screw fixing.

For Duratherm 300 (70mm)

ETC080 & ETC083 (115° - 129°)

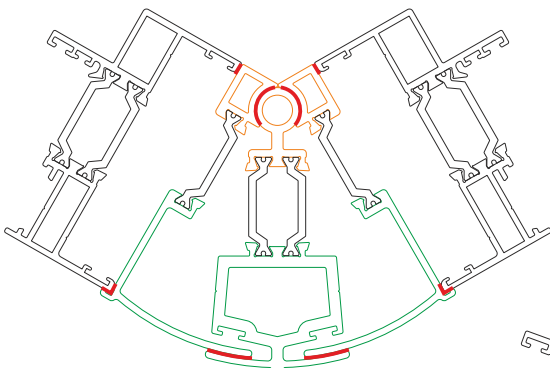

ETC080 & ETC081 (150° - 169°)

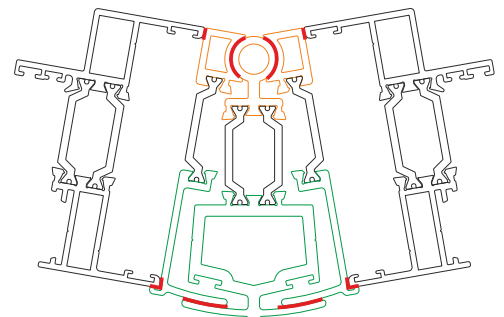

ETC080 & ETC082 (130° - 149°)

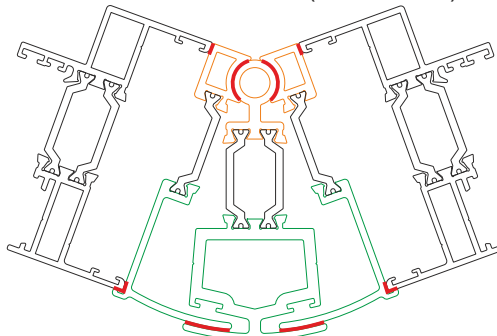

Bay Poles

- Internal Section Of Corner Post
- External Section Of Corner Post
- Advised Area For Sealing

For Premium, Premium Plus & Tilt and Turns (70mm Frames Only)

AW718 (180° - 160°)

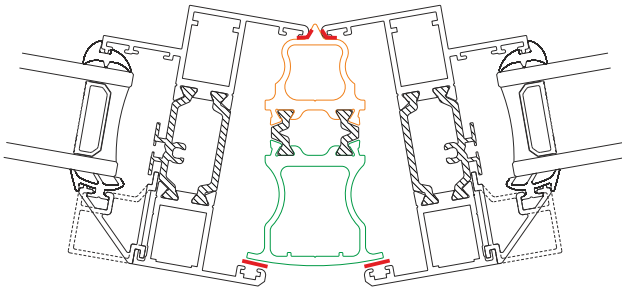

AW717 (160° - 140°)

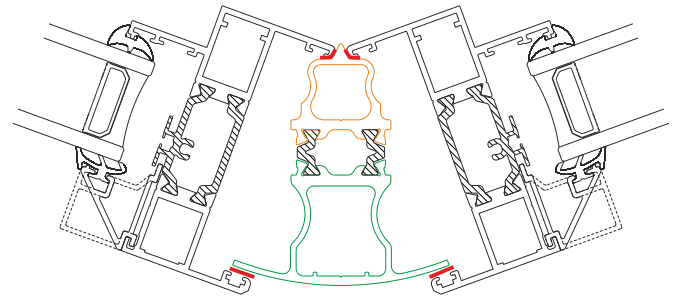

AW716 (140° - 120°)

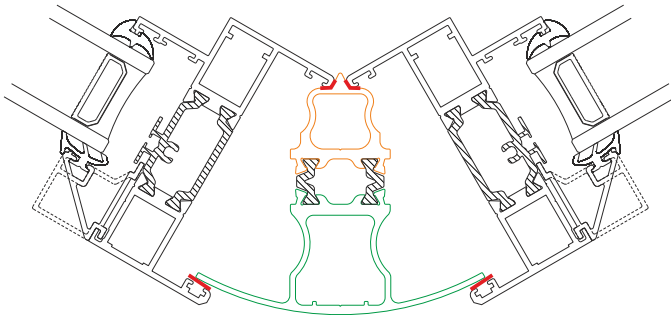

AW715 (120° - 100°)

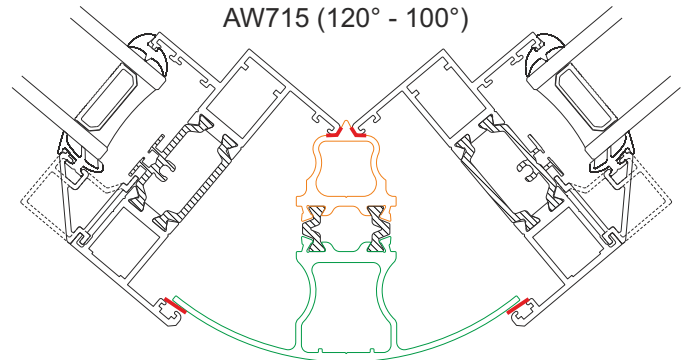

AW722 (180° - 123°)

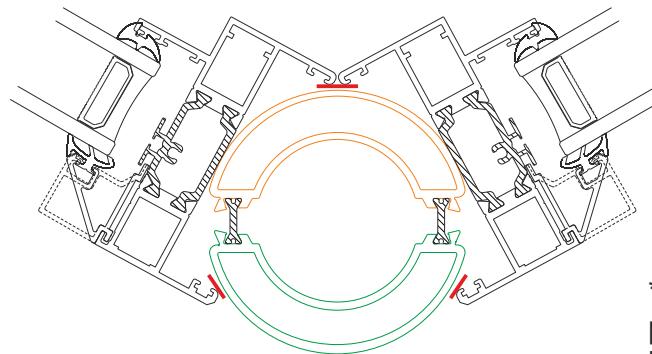

*Note on any bay assembly, packing may be required to hold poles in desired location while screw fixing.

For Premium, Premium Plus & Tilt and Turns (58mm Frames Only)

AW722 (180° - 120°)

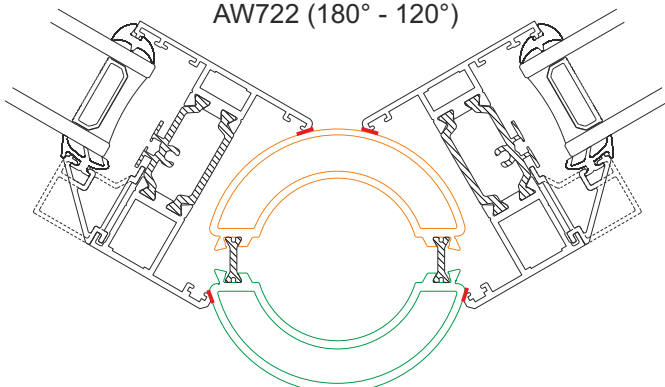

AW712 (180° - 120°)

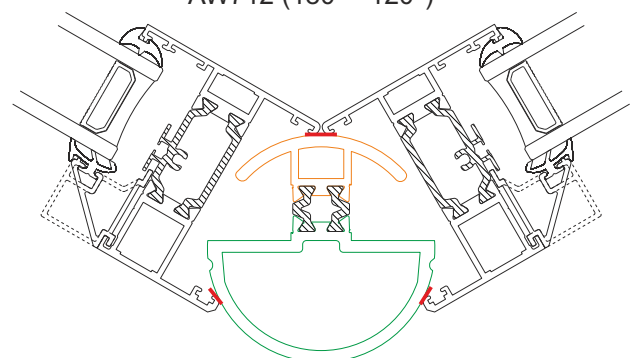

Main Office & Factory

Units 4-5, t: 01268 681612 (20 lines)
Charfleets Road, f: 01268 510058
Canvey Island, e: sales@duration.co.uk
Essex. SS8 0PQ w: www.duration.co.uk

Grand Design Exhibition Centre

Unit 1 Casino Parade, t: 01268 695100
Eastern Esplanade,
Canvey Island, SatNav Directions
Essex. SS8 7FJ Use: SS8 7DN.